

Elmeco srl
80025 Casandrino (Napoli) Italy
Via Circumvallazione esterna, 12
Uff. Commerciali:
Tel. +39 081.5055724•5054028•5057068
Fax +39 081.5055726
e-mail: info@elmeco.com
web page: www.elmeco.com

www.elmeco.com
info@elmeco.com

FIRST *Class*

**Manuale
d'uso
e manutenzione**

**Use and
maintenance
manual**

**Manuel
pour l'emploi
et l'entretien**

**Gebrauchs- und
Wartungs-
handbuch**

**Manual
de empleo y de
mantenimiento**





A quality choice

You have demonstrated your sensitivity towards innovation by having chosen Elmeco and, especially, **First Class**, the new, and presently the only, multifunctional machine with a double auger system. We therefore thank you for having understood the importance of working with a company that believes that the word “quality” is not an abstract term.

All of us at Elmeco know that quality demands concrete effort. It means repeating the innovative distinctive qualities that have set us apart in the past as inventors of the first machine for slush and that today reassert us as the leader in groundbreaking techniques and technology. It means operating with the goal in mind to

continuously improve our organization and management, according to the ISO 9001. It means placing the customer at the center of attention and dedicating investments and resources to satisfy his needs continuously.

On the other hand, to you, having chosen the Elmeco quality means being able to operate with reliable and lasting products, being able to count on timely and qualified assistance, and being able to always work better with greater profits.

Yes, because the Elmeco quality reflects the quality of your work.



UNI EN ISO 9001
CERTIFICATE No.
9130 . ELM 9



ISO 9001
QUALITY CERTIFICATION

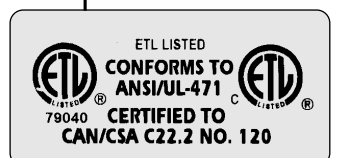
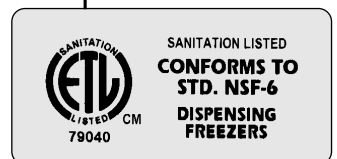

I

Indice

Istruzioni e avvertenze generali	2
Installazione del nuovo apparecchio	3
Comandi e segnalazioni	4
Pulizia e manutenzione	5
Come iniziare la produzione di granita, sorbetto o bibita fredda	6
Defrost timer	6
Regole fondamentali di sicurezza	6
Smaltimento del vecchio apparecchio	7
Assistenza tecnica	7
Impianto elettrico	8
Impianto frigorifero	9
Descrizione Codici	10
Ricambi fuori dagli esplosi	11
Esploso	56

GB

Index

General instructions and warnings	13
Installing the new machine	14
Controls and signals	15
Cleaning and maintenance	16
How to begin producing slush, sherbets or cold drinks	17
Defrost timer	17
Fundamental safety rules	17
Disposal of the old machine	18
Technical Assistance	18
Electric System	19
Refrigerating System	20
Code description	21
Spare parts not indicated in the enlarged drawings	22
Exploded view	56

F

Index

Instructions et remarques générales	24
Installation de l'appareil	25
Commandes et signalisations	26
Nettoyage et maintenance	27
Comment commencer la production de granité, sorbet ou boisson froide	28
Defrost timer	28
Règles fondamentales de sécurité	28
Mise au rebut de l'appareil	29
Service après-vente	29
Installation électrique	30
Installation frigorifique	31
Codes et description	32
Pièces non comprises dans les vues éclatées	33
Vues éclatées	56

D

Inhaltsverzeichnis

Anweisungen und allgemeine Hinweise	35
Installation der neuen Maschine	36
Bedientasten und Meldungen	37
Reinigung und Wartung	38
Wie beginnt die Herstellung von Gramolaten, Eis oder kalten Getränken	39
Defrost timer	39
Grundlegende Sicherheitsmaßnahmen	39
Entsorgung der alten Maschine	40
Kundendienst	40
Elektrik	41
Kühlanlage	42
Beschreibung der Ersatzteile	43
Ersatzteile außerhalb der Explosionsdarstellungen	44
Explosionsdarstellung	56

E

Índice

Instrucciones y advertencias generales	46
Instalación del nuevo aparato	47
Mandos y señalizaciones	48
Limpieza y mantenimiento	49
Cómo empezar la producción de granizada, sorbete o bebidas frescas	50
Defrost timer	50
Reglas fundamentales de seguridad	50
Eliminación del viejo aparato	51
Asistencia técnica	51
Instalación Eléctrica	52
Aparato Frigorífico	53
Código Descripción	54
Piezas de repuesto de los despieces	55
Despiece	56

General instructions and warnings

The First Class furnishings have been studied down to the last details, hence the luminous display on the front and back of the cupola, designed for your convenience (fig. ❶).

Before setting the machine at work, carefully read the instructions in this service manual; having done this you will be capable of installing, using, and carrying out maintenance on the machine properly.

Conserve the use and maintenance instructions

with care for your own purposes and for future owners of the machine, as well. The Manufacturer declines all responsibility for damages incurred due to disregard of the following instructions:

Carry out installation according to the instructions for assembly. The electric circuit must correspond to the rating plate data placed on the front part of the machine, under the drip tray. (fig. ❶).

Disconnect the equipment from the electrical source during maintenance, cleaning, and in case of faulty operation by unplugging the plug from the outlet (pull the plug, not the cable) (figs. ❷ and ❸).

Repairs must be carried out exclusively by authorized and specialized personnel. Faulty repairs can be extremely dangerous for the user. Contact the Company for the nearest Authorized Assistance Center.

TOP LIGHT

TRANSPARENT TANK

SERVICE KNOB

HOOKS FOR CONTAINER EXTRACTION

OUTLET

GENERAL SWITCH

DRIP TRAY

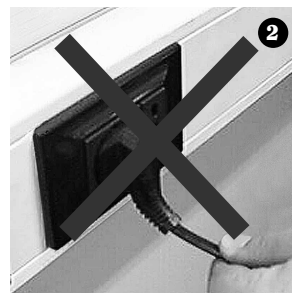

❹

ELMECO s.r.l. Via Circumvallazione esterna, 12
80025 Casandrino (NA) ITALY
Tel. 081/5055724-5054028-5057068-FAX 081/5055726

Modello Nr. Matricola

Freon Grammi Gr. Voltaggio V

Frequenza Hz Potenza W Corrente A



O.P.

R404A

Installing the new machine

This model for making grated ice-drinks, sherbets and cold drinks guarantees a completely homogenous product with the ability to adjust the product's density by using the innovative electronic controls. Before installing the machine check that:

- the machine has not been damaged during transportation. If you have any doubts, contact your supplier.
- The electric system is grounded, according to laws in force.
- The electric capacity of the system is adequate to the maximum power of the machine (as indicated in the rating plate data fig. 4)

If in doubt, contact specialized personnel only.

To install the machine, carefully read the following instructions:

Warning

This machine must be used only for the purposes for which it has been designed. Any other use of the machine is considered improper and is, therefore, dangerous.

Machine description (fig. 1):

Top Lights

Transparent tanks

Service knob

Outlet

Hooks for container extraction

Electronic board

General switch

Drip Tray

Installation

It is best to have the machine installed by qualified personnel. Incorrect installation can cause harm to people or things; the manufacturer declines all responsibility for improper installation.

Once you have removed the packaging, check for any missing pieces. No packaging materials (plastic bags, polystyrene foam, nails, etc.) should be left at a child's reach because they can be dangerous.

Remove the protective plastic bands, including those inside the grilled walls.

We do not recommend using adapters, multiple outlets or extension cords for connection to the electric system. If they are necessary, only use material that complies with the safety standards in force and only for current intensity up to the amount indicated in the rating plate data (fig. 4).

Place the machine so that no heat sources are near the grilled walls. Make sure that there is a free space of at least 15 cm (12 inch.) all around the machine (fig. 5).

Warning: If the machine is not properly installed or the condenser has not been periodically cleaned, the internal and condenser temperatures may exceed the maximum temperatures allowed.

First Class is equipped with a pressure switch with indicator which switches off the refrigerator in these circumstances. Should this occur call the technical service to deal with the cause and restore operation.

Once you have connected the machine to the electric system and have switched on the general switch, check that air is coming out from the side grills (fig. 6).

Proper use





Before setting the machine at work you should clean it as shown in the "cleaning and maintenance" paragraph.

MODEL	FC1	FC1 USA	FC2	FC2 USA	FC3	FC3 USA
HEIGHT	780 mm	30.7 inc	780 mm	30.7 inc	780 mm	30.7 inc
WIDTH	240 mm	9.45 inc	430 mm	16.1 inc	620 mm	24.4 inc
DEPTH	560 mm	22 inc	560 mm	22 inc	560 mm	22 inc
WEIGHT	33 kg	72.7 pounds	53 kg	116.8 pounds	66 kg	145.5 pounds
CAPACITY	12 lt	3.17 gal	12 lt x 2	3.17 gal x 2	12 lt x 3	3.17 gal x 3
POWER	500 w	0,67 hp	820 w	1 hp	950 w	1,3 hp
VOLTAGE HZ	230/50 230/60 115/60	230/50 230/60 115/60	230/50 230/60 115/60	230/50 230/60 115/60	230/50 230/60 115/60	230/50 230/60 115/60

The firm reserves the right to make any modifications without prior notice

Controls and signals



Top Light Switching On/Off Adjusting the intensity

The top light can be switched on and off by using the  key; by keeping the  key pressed down and simultaneously using the  or , keys you can increase or decrease the intensity of the light, respectively; by pressing the  key, the display shows the light's condition and it turns off if you have turned off the light with the key; if the light is still on, it displays a number indicating the level of the lamp's intensity (2 min. - 9 max.)

Operator safety

If you open the tub by lifting the top light, the augers stop turning.

Blocking the keyboard for the auger and the cooling unit

It is possible to block the electronic board and all its keys; you can connect or disconnect the block if you lift the top light and simultaneously use the  and  keys; the decimal point of the display lights up to signal block status.



Bypass motor brake

As you know, for safety demands, when the lid is lifted, the corresponding augers to that tank are halted accordingly. Sometimes it happens that augers halted because deformed stainless steel contacts or because lost them. In this case you

can activate the electronic bypass function tender pressed the key selection slush-juice  till augers turn.

Pay attention this system disactive the safety system and the "lock out keyboard").

Once replaced the defective contact, or installed the lost contact, eliminating the electronic bypass realized previously, must be used the following procedure:

- up the lid;
 - Stop the augers pressing the key ;
 - holding pressed the , to press the key  to have the augers left again;
 - Wait until the augers are stopped and release the keys;
 - Put on the lid on the tank;
- the augers leaves again, and the electronic bypass has been eliminated.

Self-diagnostics

If the value 0, 1 or 2 flashes on the display call the service centre.

Memory configuration

All the operations and adjustments set are memorized in a non volatile memory, that is, a memory that is active even without electricity; therefore, when you switch on the machine, the tub starts working with the configuration which it had the last time it was switched off.



Minimum level signal

Machines with a minimum level probe have a local alarm that is activated when the product goes below this value; the alarm causes the top light to flash at maximum intensity and a signal available on the board

connector is activated; this can be used to control a remote alarm and/or a refilling level system. If the minimum level continues, the light stops flashing after 1 minute.

Lamp short circuit control

An accidental short circuit of the lamp activates a protective device with a quick operating time that blocks operation of the tub(s) without causing the fuses to open; this problem is indicated by the flashing display (value 8). All tubs must be re-activated as follows:

- press the  key until the display turns off (on model with multiple tubs).
- When you let go of the  key, the machine begins normal operation.
- **Important:** carry out the procedure on all tanks.
- **Call Assistance Office**
- **Note:** the value 8 may also flash if there are sudden voltage spikes in the building. Reactivate according to the procedure described previously.

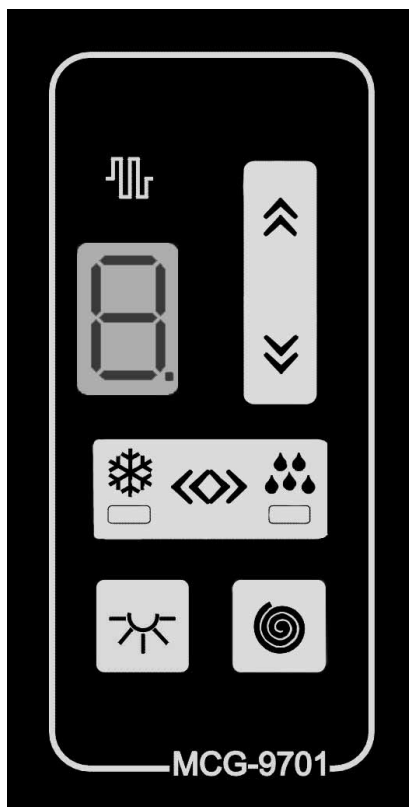

Cleaning and maintenance

Cleaning is fundamental to the machine life and conservation, therefore, it is wise to periodically clean the parts in contact with foodstuffs as indicated in the following procedure.

Warning: before every operation turn off the general switch (fig. 7) and disconnect the electric feed.

Use a solution of cold water and sodium hypochlorite (bleach), in proportions of 10 grams (1/2 Tablespoon) per liter of water. Rinse with warm water.

Warning: a largest quantity of bleach could damage the plastic auger.

Warning: if the plastic parts are washed in a dishwasher, make sure that the temperature never goes above 85° C or 185° F, otherwise they could get damaged.

Never use abrasive powders.

Cleaning procedure

See pictures at the end of the catalogue.

- Empty the containers by opening the outlet and placing the machine on the stop function (fig. 6); you can do this by opening the outlet and moving the metallic lever from left to right.
- Remove the top lights (fig. 9), pour water into the tanks, and then empty them.
- Remove the service knob (figs. 10 and 11).
- Remove the tanks by opening the hooks (figs. 12 13 14 15).
 - 12 Unscrew the tub fixing knob.
 - 13 Release.

14 and 15 Raise the container.

- Unscrew the ring nut (fig. 16) to remove the vertical auger (fig. 17).
- Remove the horizontal auger so that the stainless steel tub is completely free for cleaning (figs. 18 19).
- Remove the outlet from the tub (figs. 20 21 22 23).

20 Remove the lever cap by pressing "PUSH" and pushing it downward. Then remove the lever (fig. 21).

22 and 23 Turn the ring nut counter-clockwise and remove the complete outlet, sliding it in the axial direction.

- Soak the parts in the water and bleach solution (10g/liter of water).
- Rinse and dry.
- Wet the tank gasket before fitting it into the seat in the tub (fig. 24).
- Reassemble.
- When reassembling the tub check that the low voltage contact wires are fitted to the terminal block guides, otherwise the top light and augers will not operate (fig. 25).
- Connect the machine to the mains.

Warning: before pouring the product inside the container, turn on the stand-by switch to make sure that the augers are rotating properly.

Warning: for safety reasons, the top lights will automatically stop the auger and the cooling unit when they are removed.

Warning: it is also necessary to always keep the condenser coil clean (fig. 26) using a soft bristle paint brush (remove the filter if there is one). To access the condenser coil, remove the side panel (fig. 27).

Restriction tap

See photos at the end of the catalogue

A new accessory is added to First Class that is called **Restriction (fig. 28)**, which is shaped so as to be attached to the end of the tap of the transparent container. It has the following functions:

- the product is directed into the glass both in liquid state (cold drink) and semi-liquid state (water ice);
- the easy extractability of the restriction allows the cleaning of the ending of the tap without disassembling the entire transparent container, with a great time saving in cleaning the machine. The only non refrigerated part where some rests of product could pile up is now autonomously removable and cleanable.



⚠ The restriction must be positioned with washers (O-ring) which must be moistened before inserting them in the ending of the tap. This will help to insert the pieces and will avoid the o-rings from coming out.



There is a figure of a glass and an arrow which must be facing you while inserting the restriction.

How to begin producing slush, sherbets or cold drinks

	☾☾☾	
	°C	°F
0	OFF	OFF
1	1 (+/-1)	33.8 (+/- 1.8)
2	2 (+/-1)	35.6 (+/- 1.8)
3	3 (+/-1)	37.4 (+/- 1.8)
4	4 (+/-1)	39.2 (+/- 1.8)
5	5 (+/-1)	41 (+/- 1.8)

Refer to the panel “Control and signals” of pag. 4.

- Carry out the cleaning operations described in the preceding paragraph.
- Remove the augers and pour the mix into the transparent tank.
- Switch ON the general switch (fig. 7 see pictures at the end of the catalogue)
- Press the auger switch .
- Select slush  or cold drink .

- If you wish to increase the consistency of the slush or cold drink, press the keys  or .

- If you wish to switch on the light, press .

- **The stop outlet function can also be entered with the outlet closed. This prevents product from being delivered when the slush is being made.**

Warning: in order to prepare slush, sherbets or cold drinks you need a small amount of sugar per liter.

The amount is usually recommended in the producer’s user instructions.

- If you plan to use natural products, we recommend using an amount of sugar between 12-22%.

 If the horizontal auger has stopped due to low amounts of sugar causing blocks of ice to form or other factors, such as foreign bodies in the tub, the vertical auger may break.

Defrost timer (optional)

See photos at the end of the catalogue

The “Defrost Timer” is optional. The machine is provided with a timer that if adjusted switches the function “water ice” to “cold drink” and vice versa. This guarantees a cold product, a temperature of 2° C +/- 1° C, even during the night (Night Mode), with great advantage especially for milk products.

The machine is equipped with function deactivate Defrost timer: turn the

line of the switch knob towards the outside. Each line represents an interval of 15 minutes. The setting and therefore activating to Night Mode and Day Mode must be done during the instalment as follows:

1. open the left-side panel (FC1 and FC3) or rear panel (FC2);
2. set the timer on the correct time. The setting of the time is done by turning the switch knob clockwise until the correct time is in front of the F arrow;

3. the setting of the Night Mode and therefore of the Day Mode is done by turning the knob towards the centre;
4. close the rear and side panels .

If a “d” appears on the display of the electronic card then the Night Mode is activated.

Fundamental safety rules

- Do not touch the machine with wet hands and/or feet.
- Do not use the machine with bare feet.

- Do not allow children or inexperienced persons to use the machine.
- Do not leave the machine exposed to the weather.

- Do not pull the cable to disconnect the machine from the electrical outlet.

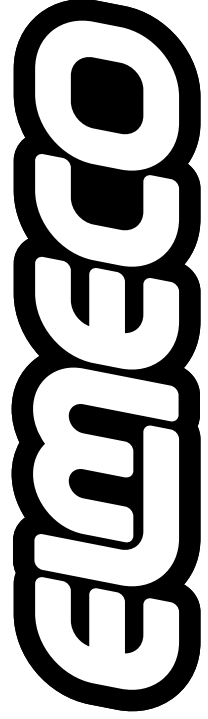

Disposal of the old machine

Machines that are no longer being used must be made non operative. Disconnect the plug from the electrical source and cut the feeding cable.

Environmental instructions

The refrigerating units must be disposed of through authorized city or private disposal facilities. Take extra precautions so that the rigid pipes of the refrigerator are not damaged before they are removed for proper ecological disposal.

All packaging materials used can be disposed of without any danger.

Technical Assistance

Any repairs to the machine must be carried out exclusively by an Authorized Service Center; repairs will be made with original spare parts. If the machine is no longer to be used, we recommend you make it non operative by cutting the power cable once you've disconnected it from the mains.

Electric System

- * Only if there is compressor timer
- ** Only for FC2 and FC3

A) Only voltage 220/240V - 50 Hz

1
Main switch

Pr
Pressure switch

LPr
Pressure switch light

TM
Timer (Optional)

8
Timer switch

C
Compressor

FM
Fan motor

TR
Transformer

7
Fuse 5x20 (2A-20VA/5A-60VA)

9
Fuse 5x20 mm F315mA

EV1-2-3
Solenoid valve

M1-2-3
Gear motor

EB1-2-3
Electronic board

O1-2-3
Magnetic or Optical reader

L1-2-3
Top light

P1-2-3
Level probe

R1-2-3
Heating element
100Kohm-0.25W

A
Suppressor filter

q1-2-3
Thermostat

Colors

- BRN Brown
- BLU Blue
- GRN Yellow-Green
- RED Red
- BLK Black
- WHI White
- GRY Grey
- VIO Purple
- ORA Orange

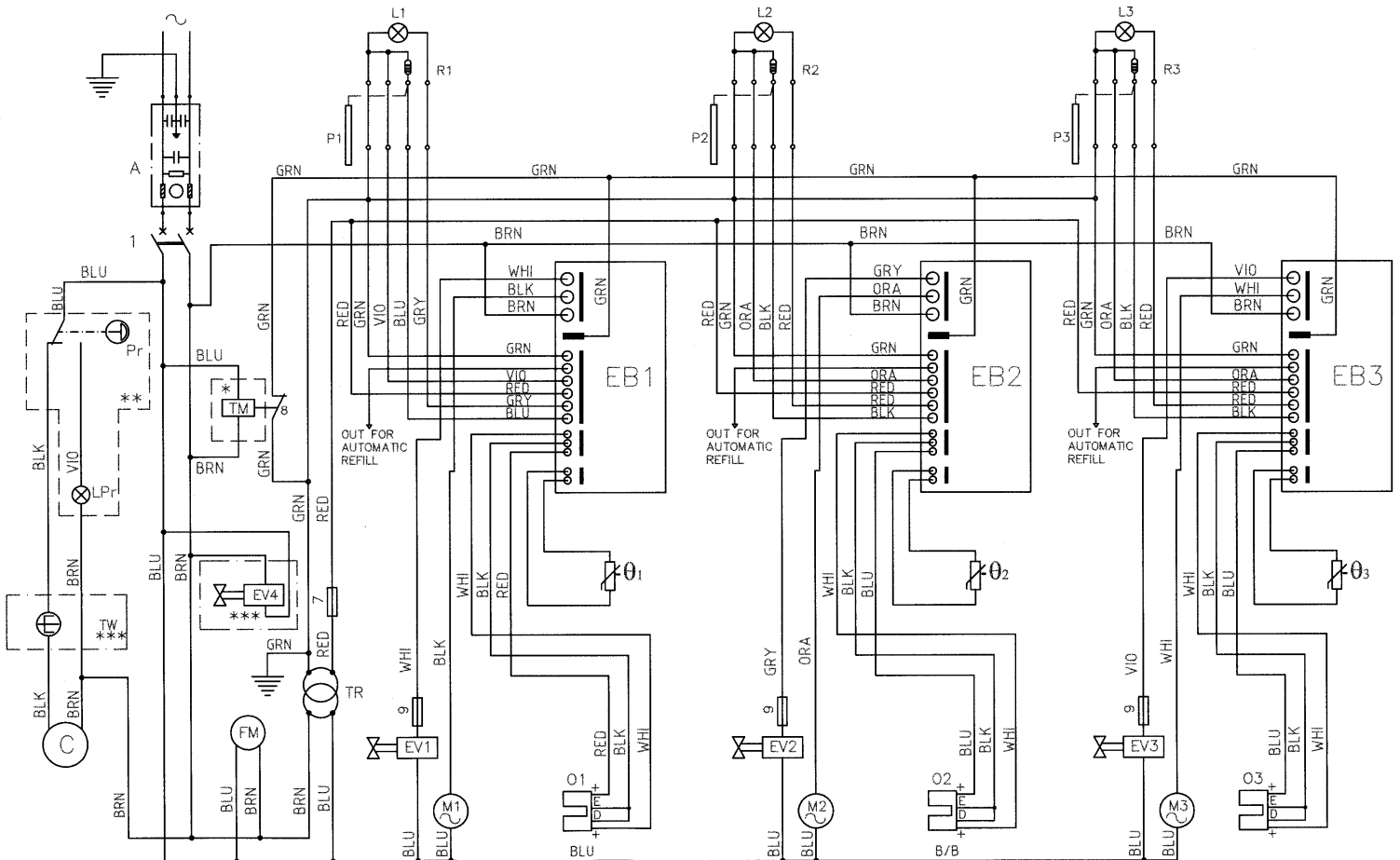

Refrigerating System

- C** Compressor
- Cn** Condenser
- F** Dryer filter
- B** Accumulator
- ev1** Solenoid valve
- ev2** Solenoid valve
- ev3** Solenoid valve
- E1** Evaporator
- E2** Evaporator
- E3** Evaporator
- 1** Discharge line
- 2** Liquid line
- 3** Suction line
- Pr** Pressure switch

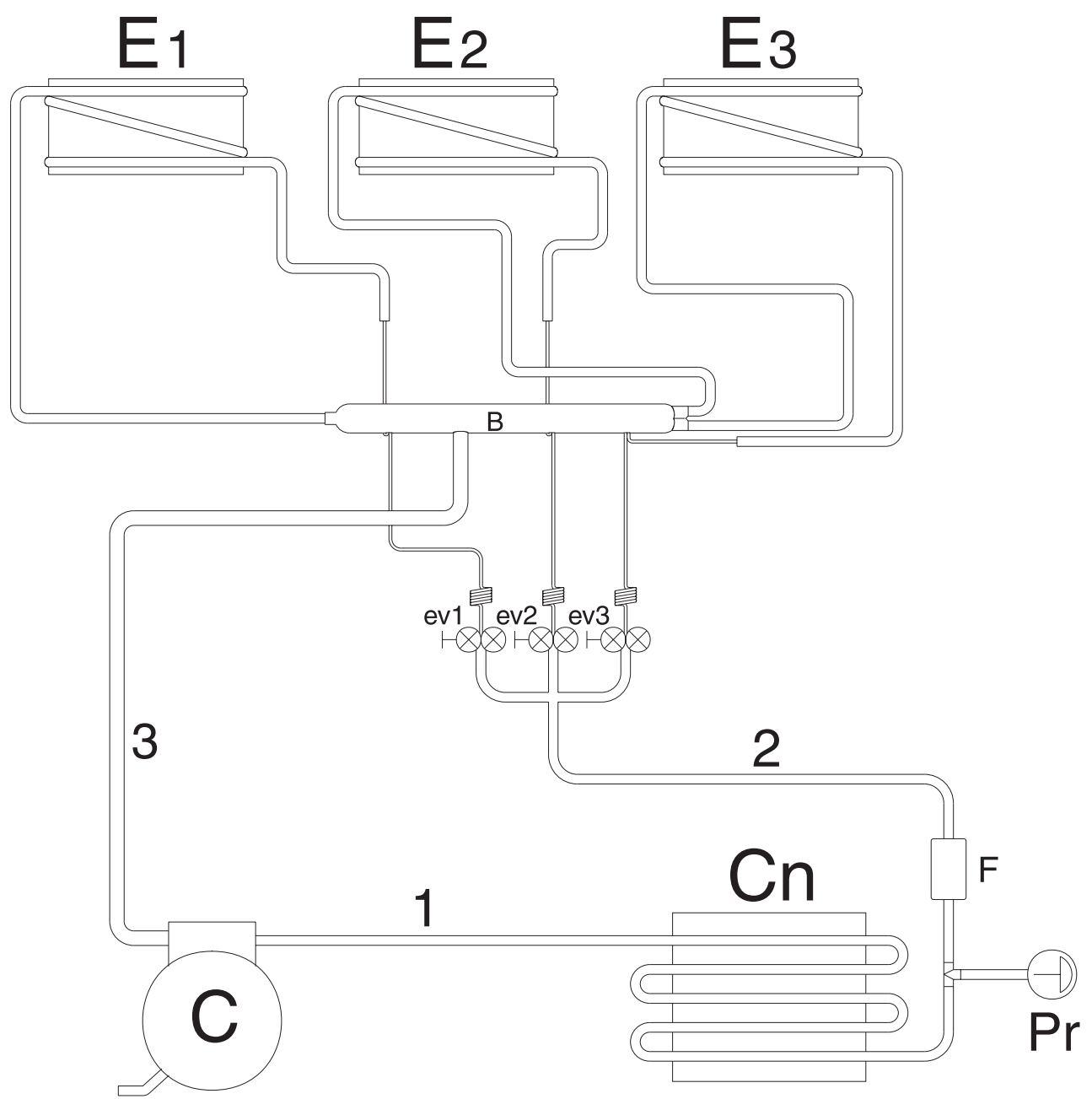

CODE	DESCRIPTION
1	M0004109-001 RING NUT HORIZONTAL AUGER
2	M0003126-001 RING NUT LEVER COVER WITH PISTON
3	M0003104 HANDLE
4	M0003108 HANDLE COVER
5	M0003124-001 PIN DRAIN LEVER
6	OR13000117 O-RING
7	M0003121-001 PISTON WITH AXE AND GASKET
8	PERNO3X28ACCIAI DOWEL D 3X28MM
9	M0003117-001 OUTLET GASKET
10	M0003106-001 PISTON SPRING
11	M0003120-001 RING NUT LEVER COVER
12	M0006134-001 DISPENSING SPOUT
13	M0000106-001 GASKET FOR TANK
14	M0000139-001 TRANSPARENT TANK WITH SLEEVE
15	M0005111-001 LOW TENSION CONTACT
16	M0005128-001 PROBE LEVEL CONTACT
17	M0006108-001 GLASS TOP LIGHT
18	M0005133-001 LAMP SOCKET
19	LAMPADA10W LAMP 12 Vac/10 Watt
20	VTTC2.9X9.5CR SCREW TC 2.9x9.5
21	M0005109-001 CONTACT
22	M0006129-001 BACK PLASTIC LENS STICKER
23	M0006121-001 BACK PLASTIC LENS
24	M0006105 TOP LIGHT COVER
25	M0006120-001 FRONT PLASTIC LENS
26	M0006128-001 FRONT PLASTIC LENS STICKER
27	M0006125 TOP LIGHT COVER COMPLETE
28	M0000107-001 RING NUT VERTICAL PROPELLER
29	M0000108-001 TRANSMISSION SHAFT WITH NUT
30	M0004103-001 VERTICAL AUGER
31	M0004104-001 VERTICAL AUGER GEAR
32	M0004108-001 WASHER SP 0,4 mm
33	M0000104-001 BUSHING TRANSMISSION SHAFT
34	M0000103-001 TRANSMISSION SHAFT
33+34	M0000140-001 TRANSMISSION SHAFT WITH BUSHING
35	M0000117-001 COTTER PIN
36	M0000114-001 TRANSMISSION SHAFT GASKET
37	M0005117 TERMINAL BOARD COMPLETE
38	M0006103 REAR HINGE
39	M0000120-001 M5 SQUARE NUT
40	M0001101-001 SCREW TE 5X12MM
41	M0000105-001 RING NUT SHAFT
42	M0002110 COMPLETE INOX TANK
43	M0005114-001 ELECTRONIC THERMOSTAT PROBE
44	M0000127-001 RUBBER SLEEVE FOR THERMOSTAT
45	M0004105-001 HORIZONTAL AUGER GEAR
46	M0004101-001 HORIZONTAL AUGER
46a	M0004102-001 HORIZONTAL AUGER BUSHING
46+46a	M0004110-001 HORIZONTAL AUGER WITH BUSHING
47	M0006116 BASE
48	M0006102 HINGE HOOK
49	M0006115 FRONT HINGE
50	M0006119-001 LOCKING BOLT
106	OR13000117 O-ring
107	M0003130-001 Outlet restriction



**Spare parts
not indicated
in the
enlarged
drawings**

- Electric System one tub
- Electric System two tubs
- Electric System three tubs
- Compressor 220/240V two and three tubs
- Compressor 115V two and three tubs
- Compressor 220/240V one tub
- Compressor 115V one tub
- Fan Motor 230V three and two tubs
- Fan Motor 115V three and two tubs
- Fan Motor 230V one tub
- Fan Motor 115V one tub
- Drain
- Transformer 230/12V
- Transformer 115/12V
- General switch
- Condenser two and three tubs
- Condenser one tub

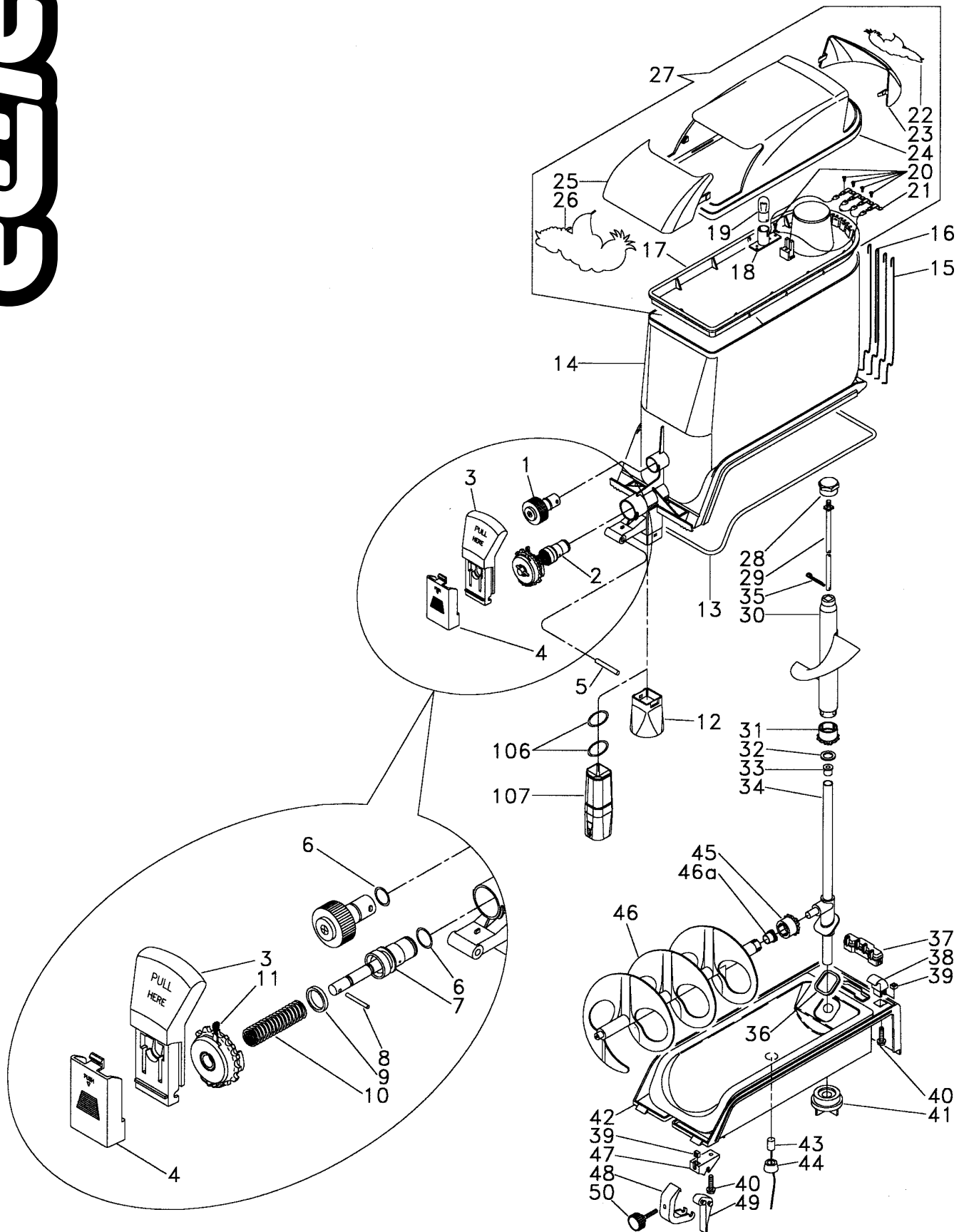

elmeccò

1 FIRST Class

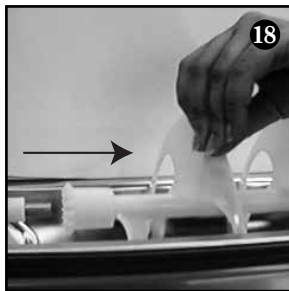
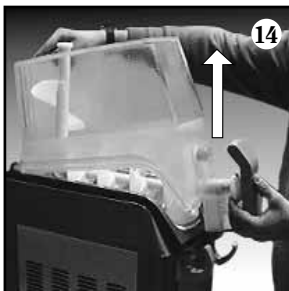
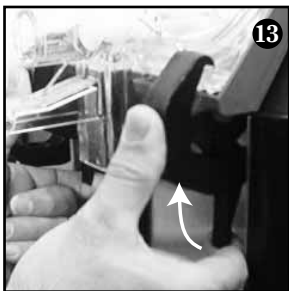
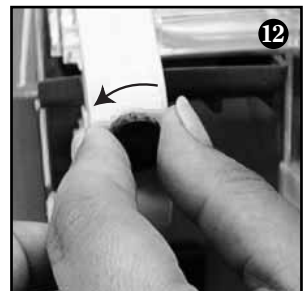
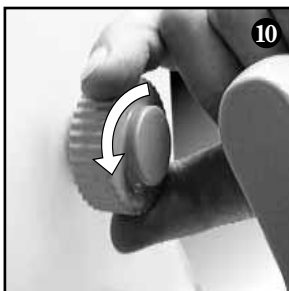
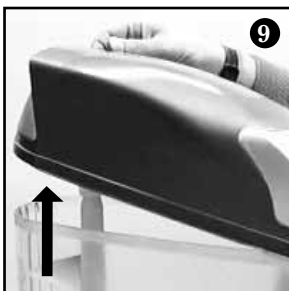
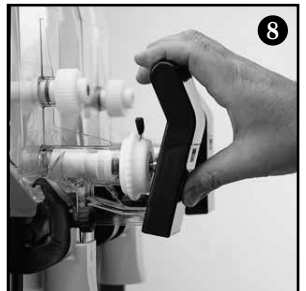
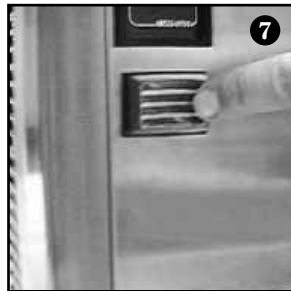
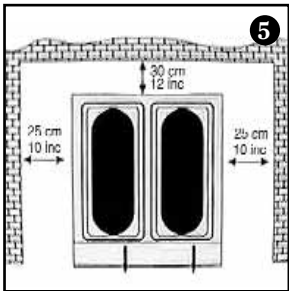

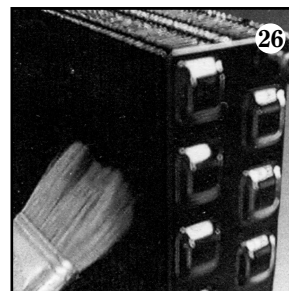
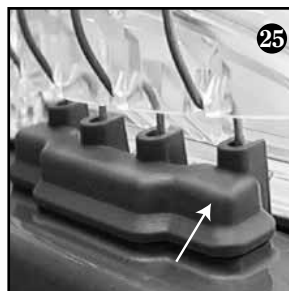
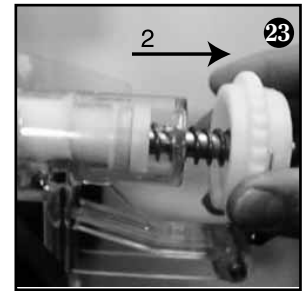
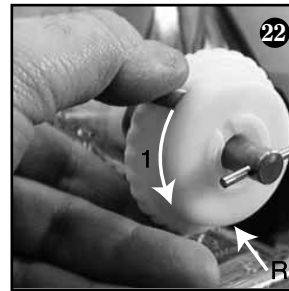
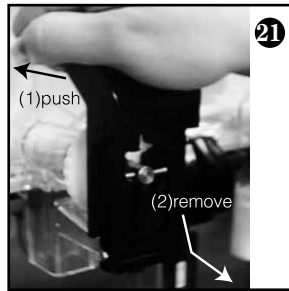
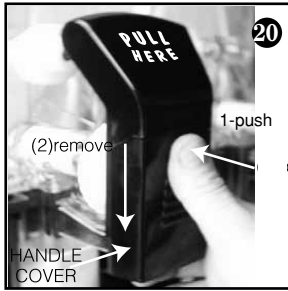

Defrost Timer

